



YZY Kit Homes

Scandinavian Way of Life

RHODES

Ideal space for your family and guests or built as B&B or rental to generate steady income



“

We could not be happier to recommend YZY Kit Homes and their exceptionally high quality products. We chose the 2 bedroom Rhodes model and are absolutely in love with it! The quality of the building, the beauty of the timber and other materials, the layout - absolutely every single part of it exceeded all expectations. Honestly, choosing YZY Kit Homes was the best decision we've made as homeowners.

Catherine and Alex, NSW



*Granny flats in this brochure are designed to be a complying development and in most cases will not require development approval (DA). Other conditions apply. Standards are different in every state, so please consult your nearest dealer of YZY Kit Homes, council or private certifier for further information.

YZY Kit Homes reserves the right to make adjustments to the specifications, sizes & materials as required. 3D images, plans & photos are for illustration purposes only. Furniture and other loose items are not included. Refer to inclusion lists for details. Building kit is not painted and comes in a natural timber finish. © Copyright YZY Kit Homes, 2020

WHO WE ARE



HEALTHY

Optimal Air humidity &
De-stress Living



SUSTAINABLE

100% recyclable, CO²
bound in wood



MADE IN EU

to AU/NZ standards



BUILT IN AU

by your local builder

YZY Kit Homes is a combination of two worlds - European made Scandinavian buildings in good hands of reputable Aussie builders. Every building we make is a result of teamwork, a collaborative effort of Australian builders, engineers and designers with architects and technical team at the factory.

We operate through the network of carefully selected Authorised builders across Australia and New Zealand. YZY Kit Homes accredited builders have experience building YZY Kit Homes and are conversant with local building regulations. They will recommend the most cost-effective and suitable floor plan and building design to suit your property. Using one of our architecturally designed plans or a tailored concept based on your specifications, we will create a unique living space perfect for you.

COMPLIANCE AND ENGINEERING

Every building is made to the highest European standards, engineered to AU/NZ Standards and built in accordance with the Australian Building Code.



BENEFITS

1. Assembled in 3-5 days
2. No need for wall lining
3. Flexible building design
4. Made of LGL laminated timber
5. Energy efficient timber mass walls and DG windows
6. Suits to hard-to-access sites



RHODES

2  | 1 



A country classic English cottage style Rhodes (9.4 m x 8.3 m) is a 2 bedroom design with a high-pitched ceilings and trendy exposed beams that make a building extremely airy and spacious. Open plan living, dining and kitchen space with abundance of windows seamlessly brings the outdoors into your house. The decking can easily be wrapped right around the sides to create even more versatile outdoor living space.

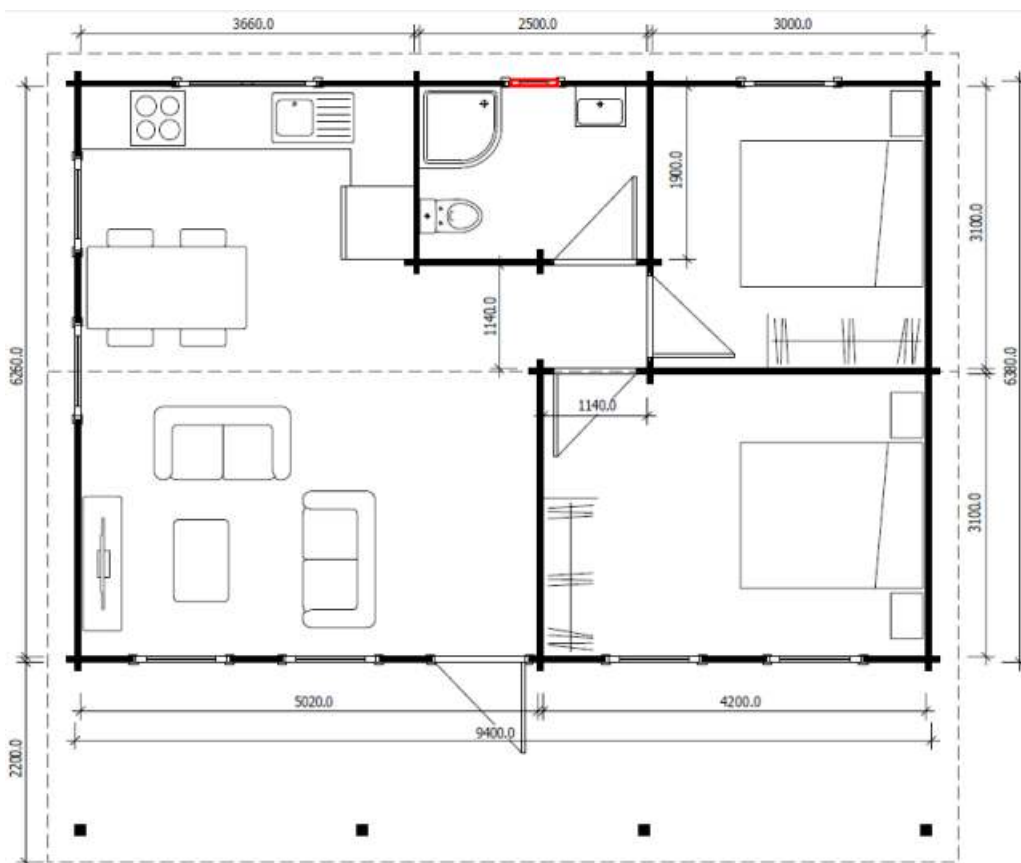

LIVING ZONE
60 m²

VERANDA
18 m²

TOTAL SIZE
78 m²



Floor plan can be flipped



Customizable placement of windows marked red on the floor plan

FEATURES

- Living area less than 60m² conforms to council requirements for a 2nd dwelling
- High-pitched ceilings up to 3680mm make an airy and open space
- Trendy exposed beams make a striking statement in your new home
- Open plan living, kitchen and dining flows out to full front veranda
- Generously sized main bedroom
- Huge full length under roof veranda
- Good airflow throughout home

DRAWINGS

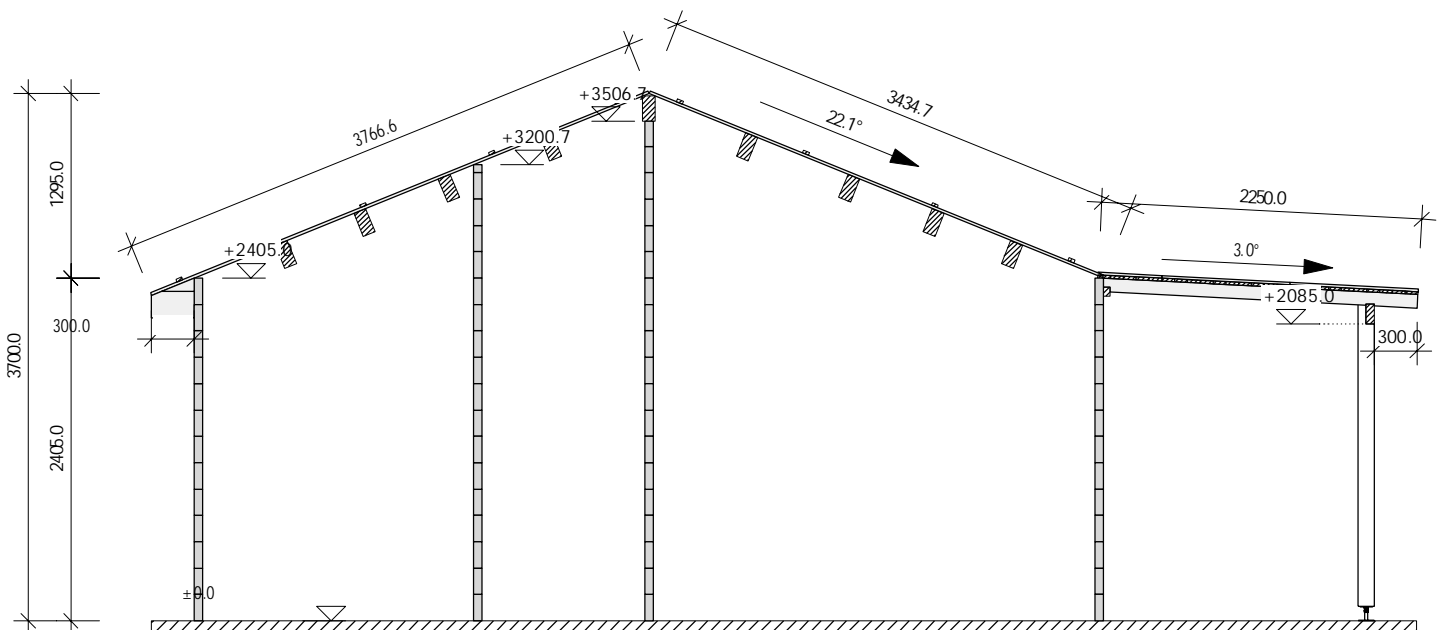
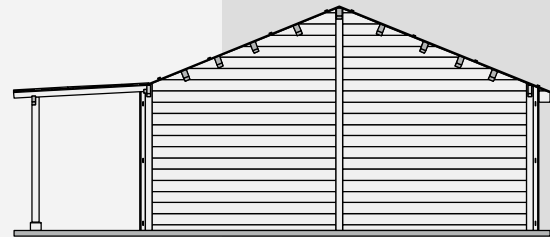
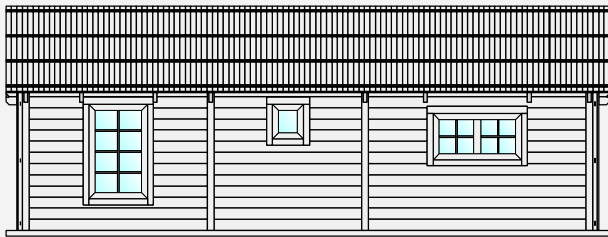
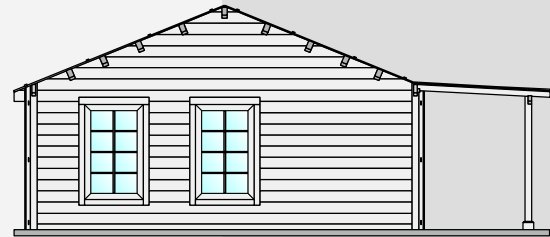
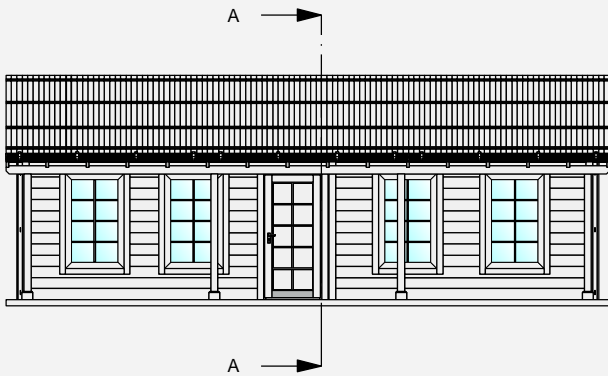

STRUCTURAL COMPONENTS MADE IN EU

Every YZY Kit Homes granny flat becomes unique with the flexible options and colours of your choice and yet cost-effective as the structure of the building is pre-cut at the factory in EU.

- Structure of load-bearing external and internal walls, kiln-dried LGL laminated Nordic Spruce, thickness 60/80mm
 - Roof structure 9 LGL load-bearing rafters, thickness 90mm, h = 175mm
 - Verandah structure: 1 LGL load-bearing rafter, thickness 60mm, h = 140mm and 16 beams, thickness 45mm, h = 95mm, 20mm T&G ceiling boards (made in sheets approx 900mm)
 - 4 laminated timber posts with adjustable legs, 115x115mm
 - 20mm T&G ceiling boards (made in sheets approx 900mm)
 - Ceiling trimmings
 - Fascia boards
 - 33 pre-drilled 18mm Ø channels, 14 for electricity and 19 for the structural tie-down system
 - Timber covers for all external corner nibs
 - External Double-glazed 4/16/4mm doors and windows, REHAU uPVC white colour frames
 - 1 external door, w1000 x h2110mm, safety DG glass.
 - 7 tilt&turn windows, w1000 x h1600mm
 - 1 sliding window, w1500 x h880mm
 - 1 tilt&turn window, w550 x h610mm, safety DG glass, customizable placement, refer to the floor plan
 - doors and windows are already installed into the timber frames with architraves
 - fitted fly screens for tilt&turn windows in REHAU uPVC frames
 - 3 internal timber doors, w820 x h2000
 - All hardware
 - Drawings for assembly with all boards marked
 - Set of drawings including generic engineering and structural certificate
 - Walkthrough 360-degree interactive 3D model, online viewer
- Note. Doors and windows are available in timber frames. Windows can be fixed or tilt&turn; doors can be single hinged or French.

FLEXIBLE COMPONENTS SOURCED FROM AU

Flexible components are sourced locally, so your local builder could customize the parts to suit your taste and budget.

To build a granny flat to the **lockup stage**, the following is required:

- Timber or steel sub-floor with yellow tongue flooring or a slab base
- Tie-down steel rods
- Colorbond roofing (colour of your choice) with insulation
- Gutters and downpipes

To build a granny flat to the **turnkey stage**, the following is required.

- Veranda/decking (can be the custom size)
- Timber Handrail and external steps (optional)
- Internal lining and/or external cladding (optional)
- The flooring coverings of your choice
- Bathroom fit-out
- Kitchen fit-out
- Electrical
- Plumbing
- Painting

THE FREEDOM OF DESIGN



Custom Design

If you need any changes to our standard range of granny flats or wish to make your own design come to life, bring it on! YZY Kit Homes are notable for their flexibility in design. Team of engineers and designers will find the best structural solution to any custom design. Over 200 people on average working with automated and computerised production lines enable us to adapt and fulfil any custom request.

Windows

YZY Kit Homes offer top-performing and energy-efficient German DG windows in uPVC or Timber frames. But if you have your favourite Australian made local windows - not a problem, we will incorporate them in the building design.

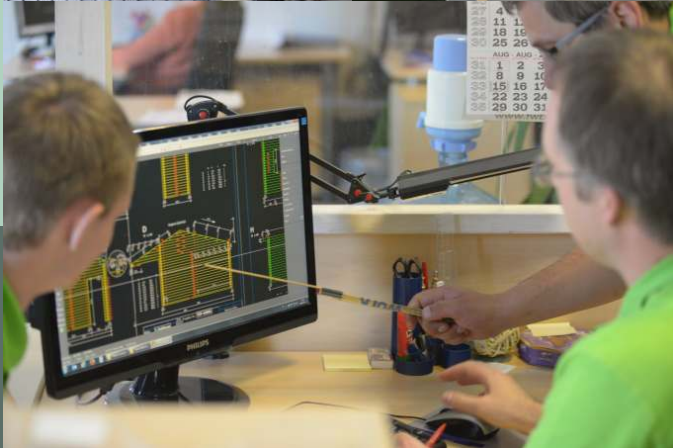

Walk through your building before order



We will model your building in 3D, so you can check every detail, walk through the building before confirming your order



Choice of interior walls style

Paint or stain your walls and you'll have that relaxing holiday house feel. Or add internal lining to achieve more traditional look. Interior design combining timber walls with some dry walls usually looks well styled, modern and cozy.

More choice

Following flexible options are sourced locally by our accredited builders, so pick and choose to suit your taste and budget.

- Timber or steel sub-floor or a slab base
- Custom size veranda and decking
- Timber Handrail and external steps
- Colorbond roofing in colour of your choice
- The flooring of your choice
- Kitchen and bathroom fit-outs



Pro-installed by the experienced builder or DIY

Whether you wish your cabin to be fully installed and connected to services or want to do it yourself, your local builder and supplier will be looking after your project all the way – from the site inspection and consultation how to best satisfy your needs until your new space is completed.



ENERGY EFFICIENCY



Europe is leading the way producing energy efficient solid timber homes. Timber mass walls act like "thermal batteries" storing heat during the day and gradually releasing it at night. YZY Kit Homes are energy efficient and eco-friendly buildings that will please you in the years to come.

To achieve a sufficient or desirable energy efficiency rating, there are 2 options:

OPTION 1

Have your granny flat built in 60mm, 80mm, 95mm, 120mm or 140mm thickness LGL walls that will not require extra insulation even in the hottest or coolest regions of Australia.

OPTION 2

Have a minimum thickness of the walls required structurally with external cladding or internal lining and added extra insulation in between. Some cladding options will not require maintenance and can be fire resistant.



“

I'm very comfortable in my new home. Anybody who has come to my new home was very very impressed! And I was amazed about how well the building insulated is. I only turned the Air conditioner on once or twice during summer even on we had 5 days straight of over 40 degrees.

John, NSW



PAINTING OR CLADDING

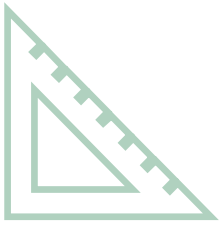

Exterior of your new space makes a big impression on overall feel and look. Choose beautiful paint color scheme possibly matching the existing house or the surroundings or achieve any architectural design with added external cladding.



Narrow your choice down knowing your site



When it comes to decide on the exterior finish of your granny flat, it's definitely worth asking your builder for a professional advice. Local council regulations and orientation of your building may limit your choice.

Bushfire Attack Levels (BAL)

BAL ratings of your property will play a huge role in what you can and can't use. Using fire resistant paint system, YZY Kit Homes may not require external cladding in areas rated up to BAL-29. For areas of more than BAL-29 fire-resistant external cladding will be required.



FACTORY

YZY Kit Homes manufacturing facility is well-known for its state-of-the-art German-made technology and highly skilled staff. Our fully automated timber machining technology allows achieving excellent dimensional accuracy. Precisely pre-cut parts enable easy and quick building process, so you have your building erected on-site within a few days.

Over 30 years of operation, the factory has delivered more than 150,000 various sized buildings including residential homes, commercial buildings, backyard cabins and sheds. Producing and delivering not only to Scandinavia or other European countries like the UK, Germany and Holland but also to Australia, New Zealand, USA, Japan, China makes processes easy. From designing homes following the market specifics to a safe and sound delivery through long distances are well-known processes mastered during the years.



Sicilia 20m² studio at night - a Pop-Up Restaurant for IKEA Growroom launch in an Iconic place Sydney

Consult with your local builder about your building project today

Find your nearest Display Village or YZY Kit Homes accredited builder, more information and a full range of cabins, studios and granny flats
www.zykithomes.com.au

Latest news, deals and videos - let's connect!
www.zykithomes.com.au

